







**SAFETY  
FOR  
EVERYONE**

# Catalog



**FACE**  
Protection

**P01**



**ARC FLASH**  
Protection

**P17**



**EYES**  
Protection

**P23**



**WELDING**  
Protection

**P25**



**HEARING**  
Protection

**P29**



**BREATHING**  
Protection

**P31**



**HEAD**  
Protection

**P39**



**HOODS**  
Protection

**P43**



**EYEWASH**  
Protection

**P45**



**BLANKET**  
Protection

**P47**



**HEAT REFLECTION**  
Protection

**P49**



**FALL**  
Protection

**P59**



## Face Protection

The faceshield can be used to provide all-round protection for the face and eyes of the wearer in the work environment.

# BLUE EAGLE SAFETY Faceshields

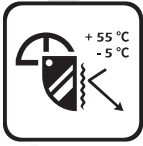

## Protection against high-speed particles

Made of extrusion grade polycarbonate with very high mechanical strength, the faceshield can withstand the impact of a 6 mm nominal diameter steel ball striking it at a high speed.

At temperature of +55 °C and -5 °C

AT 190m/s BT 120m/s FT 45m/s

At room temperature

A 190m/s B 120m/s F 45m/s



## Aluminum reinforcements

Aluminum edge reinforcements can help improve visor strength. A user can also easily bend or adjust the visor to suit usage requirements.



## Protection against molten metals and hot solids

In the test method described by the European standard EN 166, the faceshield is (1) able to prevent adherence of molten metals and provide effective protection to the user's eyes; and (2) prevent the penetration by a 6-mm diameter steel bead heated to a temperature 900 °C.



## Protection against splashes and liquids

Large visors provide broad field of vision and protection against splashes and liquids.



## Anti-fogging

Permanent anti-fogging capabilities certified to EU standards have been achieved.

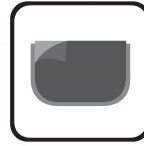

## Protective films

To ensure the best optical quality and to prevent damage and scratches during transportation, there are protective films on both sides of the visor. The films can be easily removed before use.



## Superb UV protection

We used advanced technologies to provide the user with superb protection against UV.

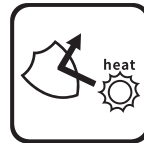

## Superb radiant heat resistance

Our innovative physical vapor deposition technology ensures that our faceshields are capable of providing excellent protection against radiant heat. Anti-radiant heat capabilities have been tested to the European Standard of EN ISO 6942 method B using a radiant heat source of 20 kW/m<sup>2</sup>, achieving the highest level of RHTI 24 > 95 s.



## Enhanced IR reflection

Enhanced IR reflection capabilities have been tested and certified to EU standards CE EN 166.



## Best optical quality

To give users the best vision so that they can focus on the job, the faceshield has the highest optical properties (Class 1) in tests of spherical refractive power, astigmatic refractive power, prismatic refractive power, and light diffusion.

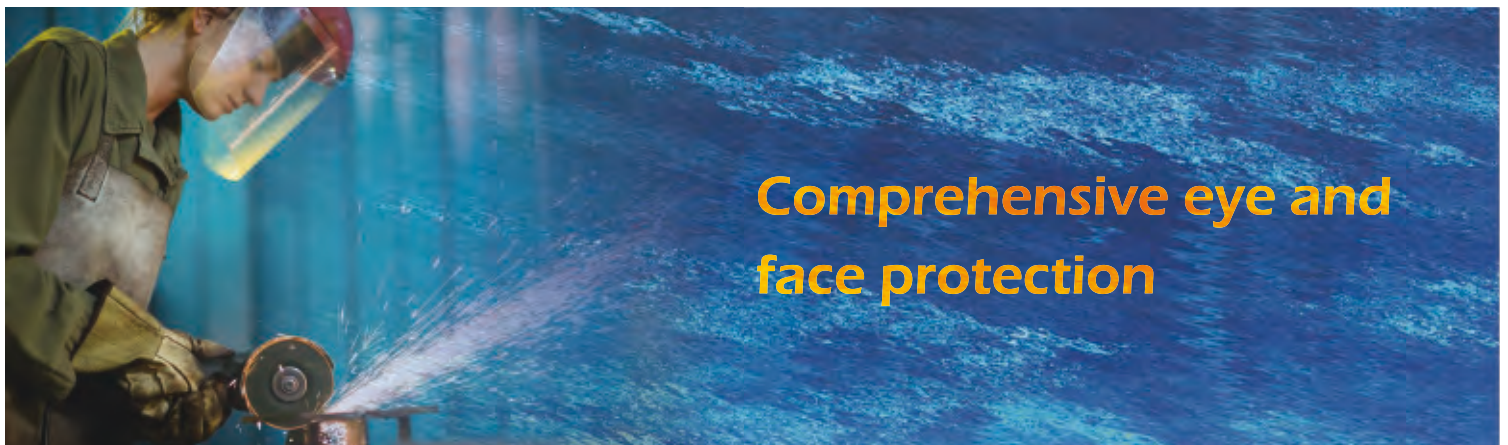

## Comprehensive eye and face protection



## ▶ FACE PROTECTION ◀







**Browguard**

- Use with FC visors
- Color : Black
- Ratchet Headgear
- Material : ABS

**D1**













**Browguard**

- Use with FC visors
- Color : Yellow
- Ratchet Headgear
- Material : ABS

**B1**











**Browguard**

- Use with FC visors
- Color : Orange
- One-push Adjustment Headgear
- Material : ABS

**B7**







**Browguard**

- Use with FC 8" x 15½" visors
- Color : Black
- One-push Adjustment Headgear
- Material : PP
- Sweatband unassembled

**DQ7**



Since 1978

# Faceshields

Size: 8x15½" (20x39cm)



CE ANSI UK CA Z94.3

**Visor**

- Impact class : BT, Z87
- Aluminum bound
- Splashes protection
- Best optical quality
- Protective films
- UV protection

**FC45**

0.8 mm Polycarbonate



CE ANSI UK CA Z94.3

**Visor**

- Impact class : BT, Z87+
- Aluminum bound
- Splashes protection
- Molten metal protection
- Best optical quality
- Protective films
- UV protection

**FC48**

1.0 mm Polycarbonate



CE ANSI Z94.3

**Visor**

- Impact class : BT, Z87+
- Aluminum bound
- Splashes protection
- Molten metal protection
- Best optical quality
- Protective films
- UV protection

**FC48T**

1.5 mm Polycarbonate



CE ANSI Z94.3

**Visor**

- Impact class : BT, Z87
- Splashes protection
- Best optical quality
- Protective films
- UV protection

**FC45N**

0.8 mm Polycarbonate



CE ANSI UK CA Z94.3

**Visor**

- Impact class : BT, Z87+
- Splashes protection
- Molten metal protection
- Best optical quality
- Protective films
- UV protection

**FC48N**

1.0 mm Polycarbonate



CE ANSI

**Anti-fog Visor**

- Impact class : F, Z87+
- Permanent Anti-fog
- Aluminum bound
- Splashes protection
- Best optical quality
- Protective films

**FC48AF**

1.0 mm Acetate



CE ANSI

**Mesh Visor**

- Impact class : F
- Forestry work
- Grass / bush trimming
- Aluminum bound
- Steel mesh

**FC49**

Steel Mesh



CE ANSI

**Mesh Visor**

- Impact class : S
- Forestry work
- Grass / bush trimming
- Plastic bound
- Steel mesh

**FC49M**

Steel Mesh







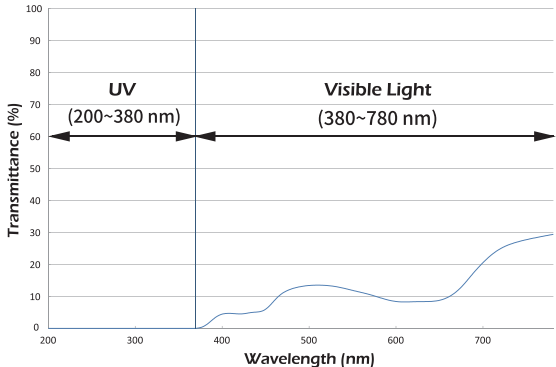



**UV Visor**

- Impact class : BT, Z87+
- UV filter : 2-3, U6
- Aluminum bound
- Splashes protection
- Best optical quality
- Protective films

**FC48G3**

1.0 mm  
Polycarbonate

CE 



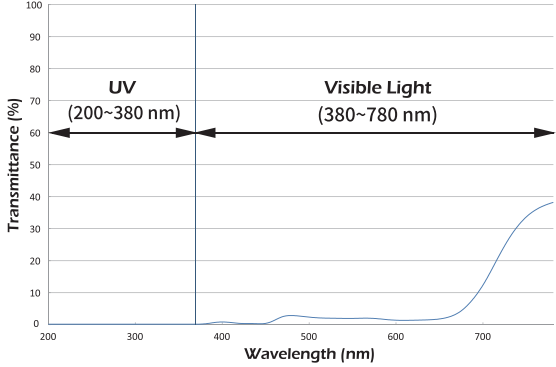

**UV Visor**

- Impact class : BT, Z87+
- UV filter : 2-5, U6
- Aluminum bound
- Splashes protection
- Best optical quality
- Protective films

**FC48G5**

1.0 mm  
Polycarbonate

CE  UK  
CA





**UV Visor**

- Impact class : Z87+
- UV filter : U6
- Splashes protection
- Best optical quality
- Protective films

**FC48G3N**

1.0 mm  
Polycarbonate





**UV Visor**

- Impact class : Z87+
- UV filter : U6
- Splashes protection
- Best optical quality
- Protective films

**FC48G5N**

1.0 mm  
Polycarbonate

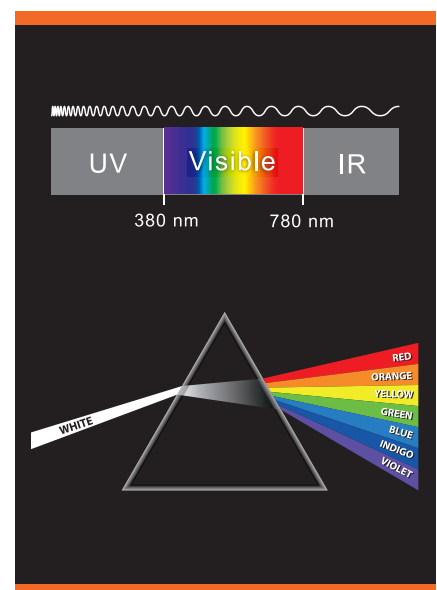

Since 1978

# Aluminized Faceshield



**Radiant Heat Protection**

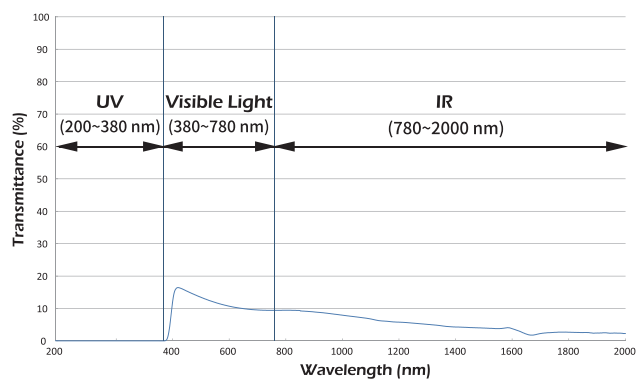

### Aluminized Visor

- Impact class : BT, Z87+
- UV filter : shade No. 2C-3 (CE certified), U6
- Enhanced IR reflectance > 70 % (CE certified)
- IR filter, shade No. R3 (ANSI Z87.1)
- Aluminum bound
- Best optical quality

**FCR3**

**1.0 mm**  
Polycarbonate

# Faceshields

Size: 8x12" (20x30cm)

# BLUE EAGLE SAFETY



CE ANSI UK CA Z94.3

### Visor

- Impact class : BT, Z87
- Aluminum bound
- Best optical quality
- Protective films
- UV protection

**FC25**

0.8 mm  
Polycarbonate



CE ANSI UK CA Z94.3

### Visor

- Impact class : BT, Z87+
- Aluminum bound
- Best optical quality
- Protective films
- UV protection

**FC28**

1.0 mm  
Polycarbonate



ANSI Z94.3

### Visor

- Impact class : Z87+
- Aluminum bound
- Best optical quality
- Protective films
- UV protection

**FC28T**

1.5 mm  
Polycarbonate



CE ANSI Z94.3

### Visor

- Impact class : BT, Z87
- Best optical quality
- Protective films
- UV protection

**FC25N**

0.8 mm  
Polycarbonate



ANSI Z94.3

### Visor

- Impact class : Z87+
- Best optical quality
- Protective films
- UV protection

**FC28N**

1.0 mm  
Polycarbonate



ANSI

### Anti-fog Visor

- Impact class : Z87+
- Permanent Anti-fog
- Aluminum bound
- Best optical quality
- Protective films

**FC28AF**

1.0 mm  
Acetate



ANSI

### Mesh Visor

- ANSI Z87
- Forestry work
- Grass/bush trimming
- Aluminum bound
- Steel mesh

**FC29**

Steel  
Mesh



CE ANSI

### Mesh Visor

- Impact class : S
- Forestry work
- Grass/bush trimming
- Plastic bound
- Steel mesh

**FC29M**



Steel  
Mesh



Since 1978

# UV Faceshields

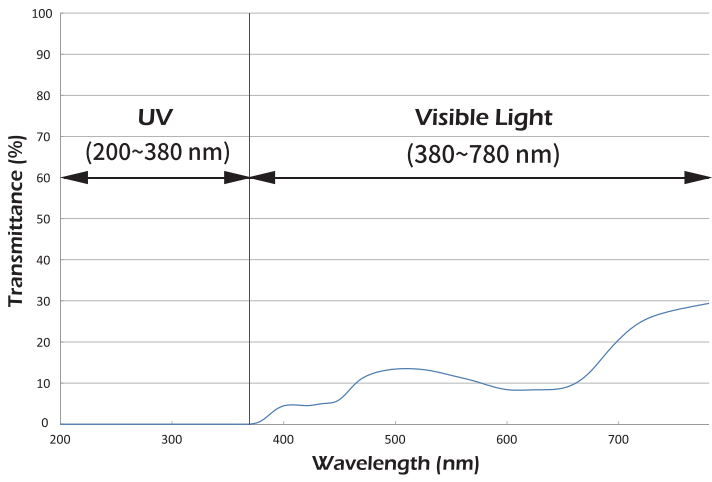
Size: 8x12" (20x30cm)



**ANSI**

**UV Visor**

- Impact class : Z87+
- UV filter : U6
- Aluminum bound
- Best optical quality
- Protective films

**FC28G3**

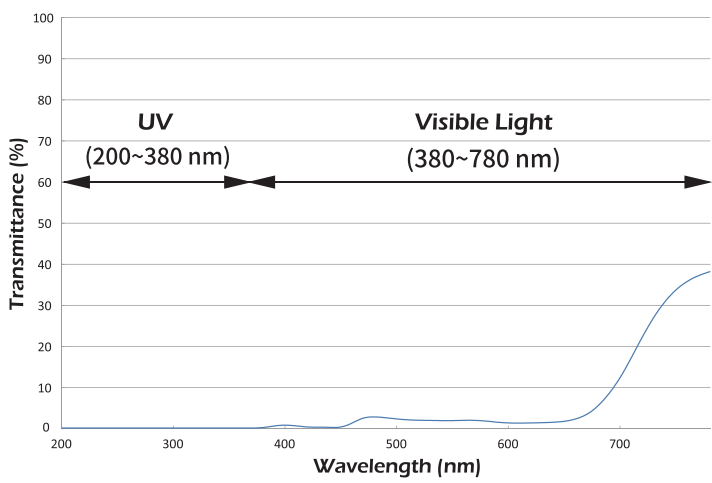
1.0 mm Polycarbonate

**ANSI**

**UV Visor**

- Impact class : Z87+
- UV filter : U6
- Aluminum bound
- Best optical quality
- Protective films

**FC28G5**

1.0 mm Polycarbonate



**ANSI**

**UV Visor**

- Impact class : Z87+
- UV filter : U6
- Best optical quality
- Protective films

**FC28G3N**

1.0 mm Polycarbonate



**ANSI**

**UV Visor**

- Impact class : Z87+
- UV filter : U6
- Best optical quality
- Protective films

**FC28G5N**

1.0 mm Polycarbonate

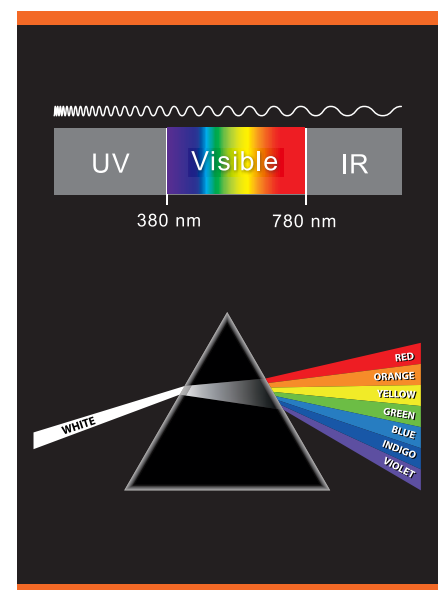



## ▶ FACE PROTECTION ◀



**Browguard**

- Use with FC visors
- Ratchet Headgear
- Material : ABS

**B1**



**Chinguard**

- Use with FC73, FC83
- Material : ABS

**C3**



**ANSI Z94.3**

**Visor**

- Impact class : Z87+
- Best optical quality
- Protective films
- Size : 8 x 15½" (20 x 39 cm)
- UV protection

**FC83**

1.0 mm Polycarbonate



**ANSI Z94.3**

**Visor**



- Impact class : BT, Z87+
- Splashes protection
- Best optical quality
- Protective films
- Size : 7 x 15½" (17.5 x 39 cm)
- UV protection

**FC73**

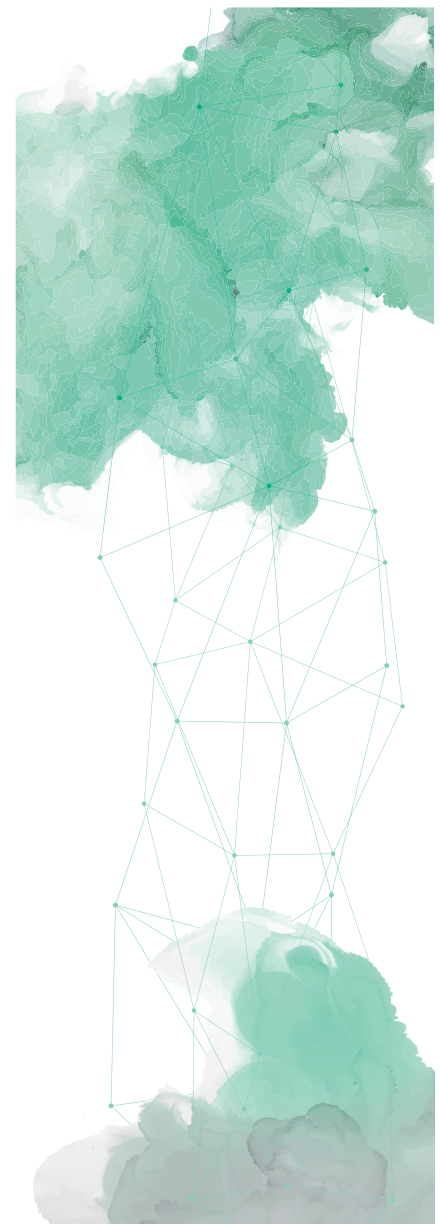

1.0 mm Polycarbonate







CE   Z94.3

**Headgear**

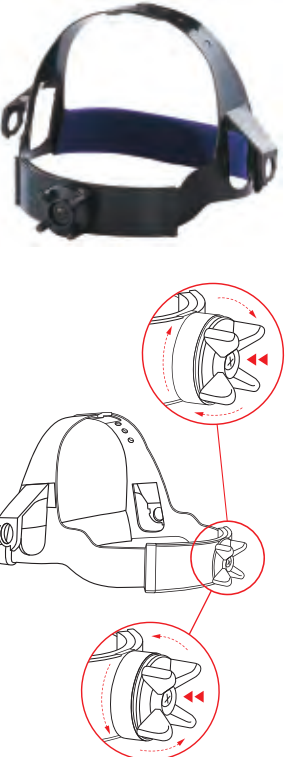

-  Ratchet adjustment
-  Fit all BLUE EAGLE browguards and welding helmets
-  Material : PP

**HG1**







**Headgear**



-  Push-and-turn ratchet
-  Fit all BLUE EAGLE browguards and welding helmets
-  Material : PP

**HG2**



CE  Z94.3

**Headgear**

-  Ratchet adjustment
-  Fit all BLUE EAGLE browguards and welding helmets
-  Material : PP

**HG3**



CE  Z94.3

**Headgear**

-  Easy manual adjustment
-  Fit all BLUE EAGLE browguards and welding helmets
-  Material : PE
-  Sweatband unassembled

**HG4**



CE  Z94.3

**Headgear**

-  One-push adjustment
-  Fit all BLUE EAGLE browguards and welding helmets
-  Material : PP
-  Sweatband unassembled

**HG7**

# Faceshields

Size: 8x12" (20x30cm)

# BLUE EAGLE SAFETY



CE (ANSI) Z94.3

### Browguard

- Use with K visors
- Color : White
- Headgear HG4
- Material : ABS
- Sweatband unassembled

**K4WH**



## ▶ FACE PROTECTION ◀



CE (ANSI) Z94.3

### Browguard

- Use with K visors
- Color : Yellow
- Headgear HG4
- Material : ABS
- Sweatband unassembled

**K4YE**



CE (ANSI) Z94.3

### Browguard

- Use with K visors
- Color : Orange
- Headgear HG4
- Material : ABS
- Sweatband unassembled

**K4OR**



CE (ANSI) Z94.3

### Visor

- Impact class : BT, Z87
- Aluminum bound
- Best optical quality
- Protective films
- UV protection

**K25**

0.8 mm  
Polycarbonate



CE (ANSI) Z94.3

### Browguard

- Use with K visors
- Color : Blue
- Headgear HG4
- Material : ABS
- Sweatband unassembled

**K4BL**



CE (ANSI) Z94.3

### Browguard

- Use with K visors
- Color : Green
- Headgear HG4
- Material : ABS
- Sweatband unassembled

**K4GN**



CE (ANSI) Z94.3

### Visor

- Impact class : BT, Z87
- Best optical quality
- Protective films
- UV protection

**K25N**

0.8 mm  
Polycarbonate

Since 1978

# Faceshields

Size: 8x12" (20x30cm)



ANSI

### Browguard

- Use with T visors
- Color : Yellow
- Ratchet headgear
- Material : ABS

**ET1**

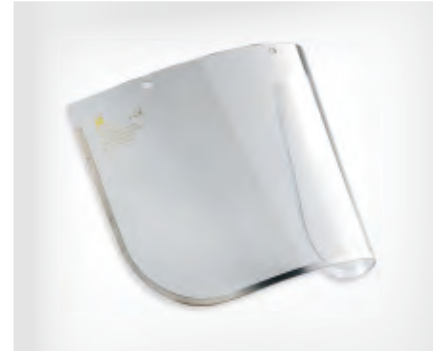

ANSI

### Visor

- Impact class : Z87+
- Aluminum bound
- Best optical quality
- Protective films
- Size : 8 x 15½" (20 x 39 cm)
- UV protection

**T48**

1.0 mm  
Polycarbonate



CE ANSI Z94.3

### Visor

- Impact class : BT, Z87+
- Aluminum bound
- Best optical quality
- Protective films
- UV protection

**K28**

1.0 mm  
Polycarbonate



ANSI

### UV Visor

- Impact class : Z87+
- UV filter : U6
- Aluminum bound
- Best optical quality
- Protective films

**K28G3**

1.0 mm  
Polycarbonate



ANSI

### UV Visor

- Impact class : Z87+
- UV filter : U6
- Aluminum bound
- Best optical quality
- Protective films

**K28G5**

1.0 mm  
Polycarbonate



CE ANSI Z94.3

### Visor

- Impact class : BT, Z87+
- Best optical quality
- Protective films
- UV protection

**K28N**

1.0 mm  
Polycarbonate



ANSI

### UV Visor

- Impact class : Z87+
- UV filter : U6
- Best optical quality
- Protective films

**K28G3N**

1.0 mm  
Polycarbonate



ANSI

### UV Visor

- Impact class : Z87+
- UV filter : U6
- Best optical quality
- Protective films

**K28G5N**

1.0 mm  
Polycarbonate



# Visor Brackets

BLUE EAGLE SAFETY



Z94.3

### Bracket

- Designed to fit most regular safety helmets.
- Provide head and face protection together.
- Fit all FC series visors.

### Visor

- Impact class : BT, Z87+
- Aluminum bound
- Splashes protection
- Molten metal protection
- Best optical quality
- Protective films

**A3**  
(Bracket)  
**FC48**  
(Visor)



### Bracket

- Use with FC visors
- Color : Black
- Material : ABS
- Fit regular helmets

**A2**



### Bracket

- Use with FC visors
- Color : Black
- Material : ABS/Aluminum
- Fit regular helmets

**A3**



### Bracket

- Use with FC visors
- Material : Aluminum
- Fit round-brim helmets

**AR4**



### Bracket



- Use with FC visors
- Material : Aluminum
- Fit regular helmets

**A4**  
(Black)  
**A4WH**  
(Silver)

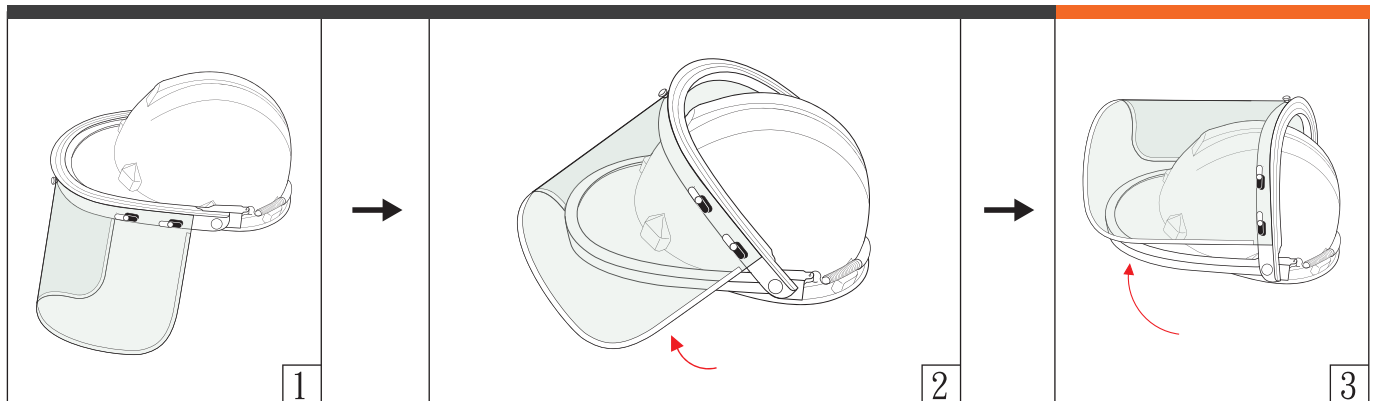
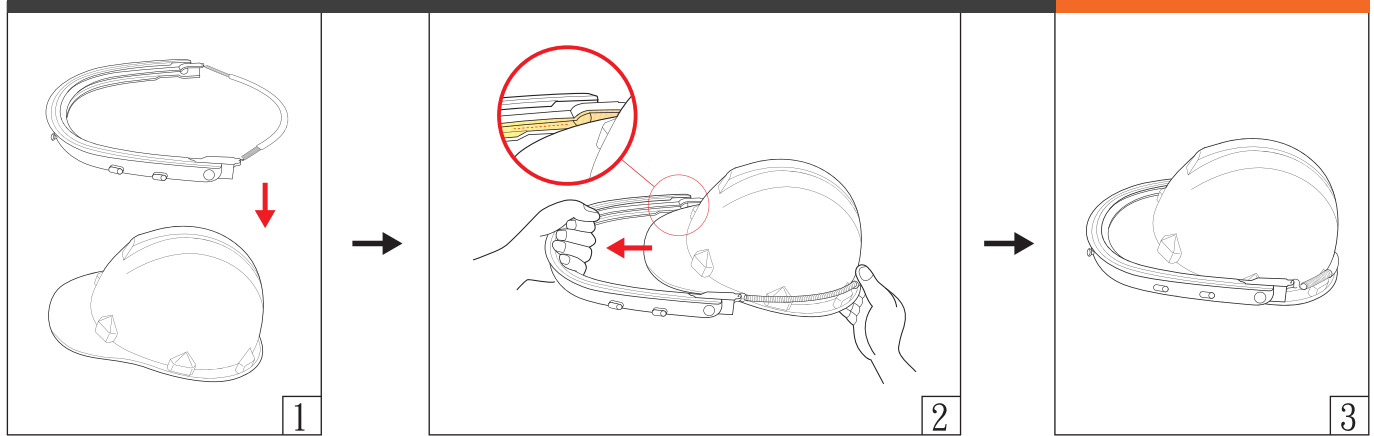

## Bracket Assembling



### Browguards and Brackets for FC series visors

Items	Material	Standards	Color	Description
B1	Impact - resistance ABS	 · CE · ANSI · UK CA · Z94.3	Yellow / Orange Blue / Green	Ratchet headgear.
B7	Impact - resistance ABS	 · CE · ANSI · Z94.3	Yellow / Orange Blue / Green	One-push adjustment headgear.
D1	Impact - resistance ABS	CE · ANSI	Black	Ratchet headgear.
DO7	PP	 · CE · ANSI · Z94.3	Black	One-push adjustment headgear.
A2	ABS	 · CE · ANSI	Black	Fit regular safety helmets.
A3	ABS / Aluminum	 · CE · ANSI · UK CA	Black	Fit regular safety helmets.
A4	Aluminum	 · CE · ANSI	Black	Fit regular safety helmets.
AR4	Aluminum	ANSI	Silver	Fit round-brim safety helmets.
A8BK	ABS	CE · ANSI	Black	Fit regular safety helmets. Fit FC 8" x 15½" visors.
A8XBK	ABS	CE · ANSI	Black	Fit slotted safety helmets. Fit FC 8" x 15½" visors.

### FC series visors ( 8x15½" or 20x39 cm )

Items	Thickness	Material	Aluminum Bound	Standards	Color	Description
FC45	0.8 mm	Polycarbonate	Yes	CE · ANSI · UK CA · Z94.3	Clear	For impact and splashes resistance.
FC48	1.0 mm	Polycarbonate	Yes	 · CE · ANSI · UK CA · Z94.3	Clear	For impact, molten metals and splashes resistance.
FC48T	1.5 mm	Polycarbonate	Yes	CE · ANSI · Z94.3	Clear	For impact, molten metals, heat and splashes resistance.
FC48AF	1.0 mm	Acetate	Yes	CE · ANSI	Clear	Permanent Anti-fog. For impact and splashes resistance.
FC48G3	1.0 mm	Polycarbonate	Yes	CE · ANSI	Green	UV filter: 2-3, U6. For UV, impact, and splashes resistance.
FC48G5	1.0 mm	Polycarbonate	Yes	CE · ANSI · UK CA	Green	UV filter: 2-5, U6. For UV, impact, and splashes resistance.
FC49	-	Steel Mesh	Yes	CE · ANSI	Black	For flying chips and splinters.
FC49M	-	Steel Mesh	No	CE · ANSI	Black	For flying chips and splinters.
FC45N	0.8 mm	Polycarbonate	No	CE · ANSI · Z94.3	Clear	For impact and splashes resistance.
FC48N	1.0 mm	Polycarbonate	No	 · CE · ANSI · UK CA · Z94.3	Clear	For impact and splashes resistance.
FC48G3N	1.0 mm	Polycarbonate	No	ANSI	Green	UV filter: U6. For UV, impact, and splashes resistance.
FC48G5N	1.0 mm	Polycarbonate	No	ANSI	Green	UV filter: U6. For UV, impact, and splashes resistance.
FC73	1.0 mm	Polycarbonate	No	 · CE · ANSI · UK CA · Z94.3	Clear	For impact and splashes resistance. (7 x 15½", 17.5 x 39cm)
FC83	1.0 mm	Polycarbonate	No	ANSI · Z94.3	Clear	For impact and splashes resistance.
FCR3	1.0 mm	Aluminized Polycarbonate	Yes	CE · ANSI	Silver	Reflect radiant heat. For UV, IR, and impact resistance.

### FC series visors ( 8x12" or 20x30 cm )

Items	Thickness	Material	Aluminum Bound	Standards	Color	Description
FC25	0.8 mm	Polycarbonate	Yes	CE, ANSI, UK, Z94.3	Clear	For impact resistance.
FC28	1.0 mm	Polycarbonate	Yes	CE, ANSI, UK, Z94.3	Clear	For impact resistance.
FC28T	1.5 mm	Polycarbonate	Yes	ANSI, Z94.3	Clear	For impact and heat resistance.
FC28AF	1.0 mm	Acetate	Yes	ANSI	Clear	Permanent Anti-fog. For impact resistance.
FC28G3	1.0 mm	Polycarbonate	Yes	ANSI	Green	UV filter: U6. For UV and impact resistance.
FC28G5	1.0 mm	Polycarbonate	Yes	ANSI	Green	UV filter: U6. For UV and impact resistance.
FC29	-	Steel Mesh	Yes	ANSI	Black	For flying chips and splinters.
FC29M	-	Steel Mesh	No	CE, ANSI	Black	For flying chips and splinters.
FC25N	0.8 mm	Polycarbonate	No	CE, ANSI, Z94.3	Clear	For impact resistance.
FC28N	1.0 mm	Polycarbonate	No	ANSI, Z94.3	Clear	For impact resistance.
FC28G3N	1.0 mm	Polycarbonate	No	ANSI	Green	UV filter: U6. For UV and impact resistance.
FC28G5N	1.0 mm	Polycarbonate	No	ANSI	Green	UV filter: U6. For UV and impact resistance.

### Browguards for K series visors

Items	Material	Standards	Color	Description
K4YE	Impact - resistance ABS	CE, ANSI, Z94.3	Yellow	Fit K series visors. Light weight.
K4OR	Impact - resistance ABS	CE, ANSI, Z94.3	Orange	Fit K series visors. Light weight.
K4BL	Impact - resistance ABS	CE, ANSI, Z94.3	Blue	Fit K series visors. Light weight.
K4GN	Impact - resistance ABS	CE, ANSI, Z94.3	Green	Fit K series visors. Light weight.
K4WH	Impact - resistance ABS	CE, ANSI, Z94.3	White	Fit K series visors. Light weight.

### K series visors ( 8x12" or 20x30 cm )

Items	Thickness	Material	Aluminum Bound	Standards	Color	Description
K25	0.8 mm	Polycarbonate	Yes	CE, ANSI, Z94.3	Clear	For impact resistance.
K28	1.0 mm	Polycarbonate	Yes	CE, ANSI, Z94.3	Clear	For impact and penetration resistance.
K28G3	1.0 mm	Polycarbonate	Yes	ANSI	Green	UV filter: U6. For UV and impact resistance.
K28G5	1.0 mm	Polycarbonate	Yes	ANSI	Green	UV filter: U6. For UV and impact resistance.
K25N	0.8 mm	Polycarbonate	No	CE, ANSI, Z94.3	Clear	For impact resistance.
K28N	1.0 mm	Polycarbonate	No	CE, ANSI, Z94.3	Clear	For impact and penetration resistance.
K28G3N	1.0 mm	Polycarbonate	No	ANSI	Green	UV filter: U6. For UV and impact resistance.
K28G5N	1.0 mm	Polycarbonate	No	ANSI	Green	UV filter: U6. For UV and impact resistance.



# Arc Flash Faceshield

Arc flash faceshields are designed for electricians during work in which a risk of a fault arc exists.

## NFPA 70E

## GS-ET-29



Electrical

Faceshields for electrical works



NFPA 70E

Comply with NFPA 70E



Impact

High impact resistance



Hot Solid

Protection against molten metals and hot solids



True Colors

True color vision



UV Filter

UV protection



IR Filter

IR protection



Best Vision

Best optical quality

### MORE INFO

Learning more about the specifications.



Rubber Band  
Fastening



Clip Fastening



Browguard  
Type



▶ ARC FLASH PROTECTION ◀





# Arc Flash Clothing

BLUE EAGLE<sup>®</sup>  
AR series arc-rated  
garment is designed  
to reduce the energy  
caused by arc flash.



## Arc-Flash PPE Categories

Arc-Flash PPE Categories (CAT)	Minimum Arc Rating (ATPV)
1	4 cal/cm <sup>2</sup>
2	8 cal/cm <sup>2</sup>
3	25 cal/cm <sup>2</sup>
4	40 cal/cm <sup>2</sup>

According to NFPA 70E

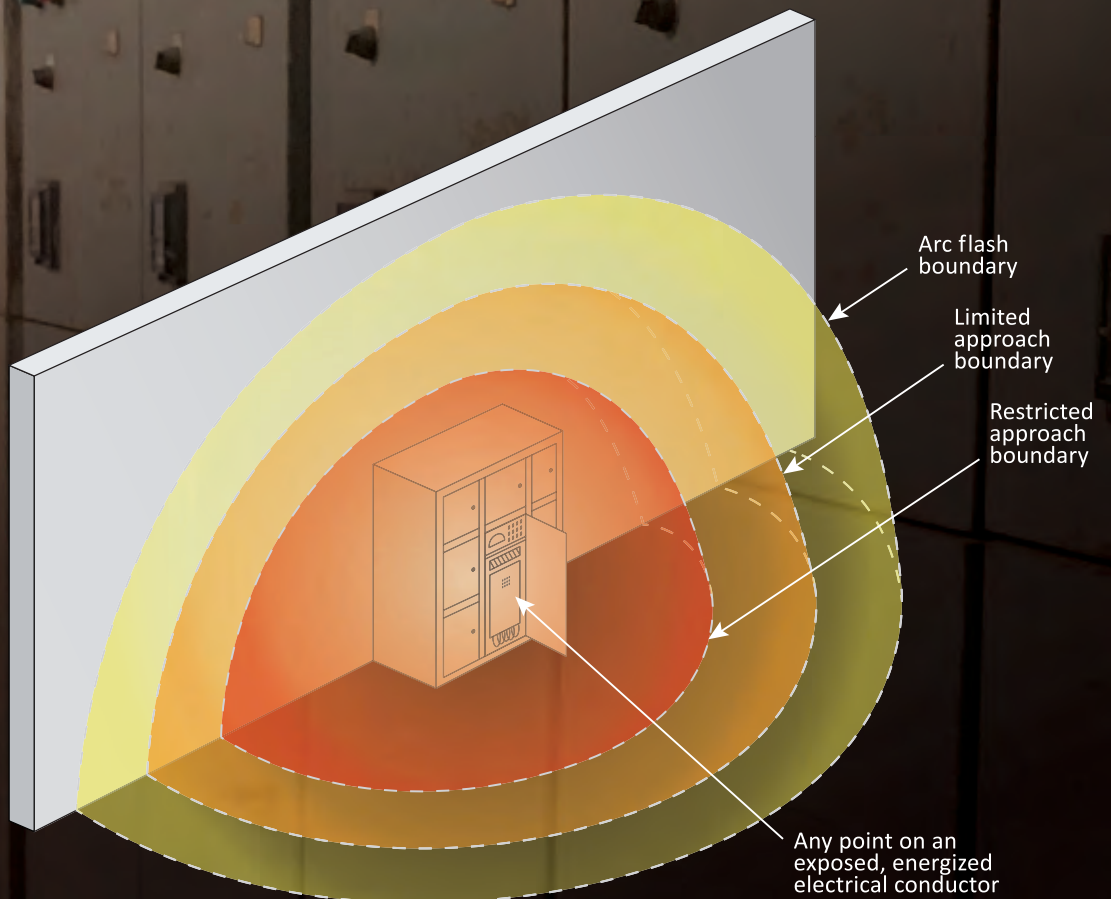



## Description

BLUE EAGLE® AR series arc-rated garment is an arc flash personal protective equipment (PPE) which is made of inherent flame resistant fabric. It is designed to reduce the energy caused by arc flash. Garment is designed in light weight for user's comfort and makes it easy to put on and take off.



## Features and Benefits

### ✓ Inherent FR Fabrics

Made of inherent flame resistant fabric and flame resistant sewing thread, BLUE EAGLE's arc flash garments have inherent, fire extinguishing properties for the ultimate protection, minimizing injury in the event of an Arc Flash incident.

#### Safety and Inherent Protection

Unlike chemically treated fabrics, which may lose its flame resistant ability after laundry, inherent flame resistant fabrics will not lose its flame resistance after washes because they have flame resistance built into their chemical structures. They can prevent the spread of fire and give peace of mind with ultimate protection.

### ✓ The Most Comfortable and Functional Design

FR hook & loop fastener, quick disconnect shoulder straps, expandable leg opening to fit over boots, pockets, elastic waistband, great adjustability and considered cutting and shaping make it the most comfortable and functional Arc Flash garments.

### ✓ Highly Durable

The fabrics have been tested to industrial washes and passing the arc flash test after washing. It also has excellent mechanical strength and color fastness.



Flame Resistant hook & loop fastener.



Elastic waistband



Expandable leg opening to fit over boots.



Quick disconnect shoulder straps



Aramid threads ensures thermal safety and durability.

Fabric specification : 380 g/m<sup>2</sup> Inherent Fabric

Color : Green

Product care :



Since 1978

# Arc Flash Clothing



## Arc Flash Hood

- Large field-of-view
- ANSI Z89.1 class E safety helmet
- ASTM F2178
- ATPV = 40 cal/cm<sup>2</sup>
- NFPA 70E PPE CAT 4
- ANSI Z87.1 – U6 R10

AR1



## Arc Flash Jacket

- FR hook & loop fastener
- Aramid sewing threads
- Elastic waistband
- ASTM F1959
- ATPV = 40 cal/cm<sup>2</sup>
- NFPA 70E PPE CAT 4

AR2



## Arc Flash Bib Overalls

- FR hook & loop fastener
- Aramid sewing threads
- Expandable leg opening to fit over boots
- ASTM F1959
- ATPV = 40 cal/cm<sup>2</sup>
- NFPA 70E PPE CAT 4

AR3



## ▶ EYE PROTECTION ◀



**ANSI** 1.5 mm Polycarbonate

**Goggle**

- Impact class : Z87+
- Polycarbonate lens
- Direct venting
- UV protection

SG152



**ANSI** 1.5 mm Polycarbonate

**Goggle**

- Impact class : Z87+
- Polycarbonate lens
- Indirect venting
- UV protection

SG154



**ANSI** 1.5 mm Polycarbonate

**Goggle**

- Impact class : Z87+
- Polycarbonate lens
- Anti-fog coating
- Indirect venting
- UV protection

SG155



**ANSI** 1.0 mm Polycarbonate

**Goggle**

- Impact class : Z87+
- Polycarbonate lens
- Direct venting
- UV protection

SG102



**ANSI** 1.0 mm Polycarbonate

**Goggle**

- Impact class : Z87+
- Polycarbonate lens
- Indirect venting
- UV protection
- Protection against droplets

SG104



**CE** **ANSI** **UK CA** 1.0 mm Acetate

**Goggle**

- Impact class : F, Z87+
- Acetate lens
- Permanent Anti-fog
- Indirect venting

NP105



CE ANSI

**Goggle**

- Lift-front type
- EN166, EN175, ANSI Z87.1
- Shade No. U6

**GW250**



ANSI

**Goggle**

- Fixed type
- ANSI Z87.1
- Shade No. U6

**GW240**



ANSI

**Spectacle**

- For furnace observation
- Green color glass
- IR, UV protection
- Filters : ANSI Z87.1 shade No. U6

**NP248**



ANSI

1.5 mm Polycarbonate

**Goggle**

- Impact class : Z87+
- Polycarbonate lens
- Direct venting
- UV protection

**NP152**



ANSI

1.5 mm Polycarbonate

**Goggle**

- Impact class : Z87+
- Polycarbonate lens
- Indirect venting
- UV protection

**NP154**



ANSI

**Spectacle**

- For furnace observation
- Cobalt blue glass
- IR, UV protection
- Filters : EN171 shade No. 4-6  
ANSI Z87.1 shade No. R10

**NP247**



CE ANSI

1.0 mm Polycarbonate

**Goggle**

- Impact class : F, Z87+
- Polycarbonate lens
- Direct venting
- UV protection

**NP102**



CE ANSI

1.0 mm Polycarbonate

**Goggle**

- Impact class : F, Z87+
- Polycarbonate lens
- Indirect venting
- UV protection
- Protection against droplets

**NP104**



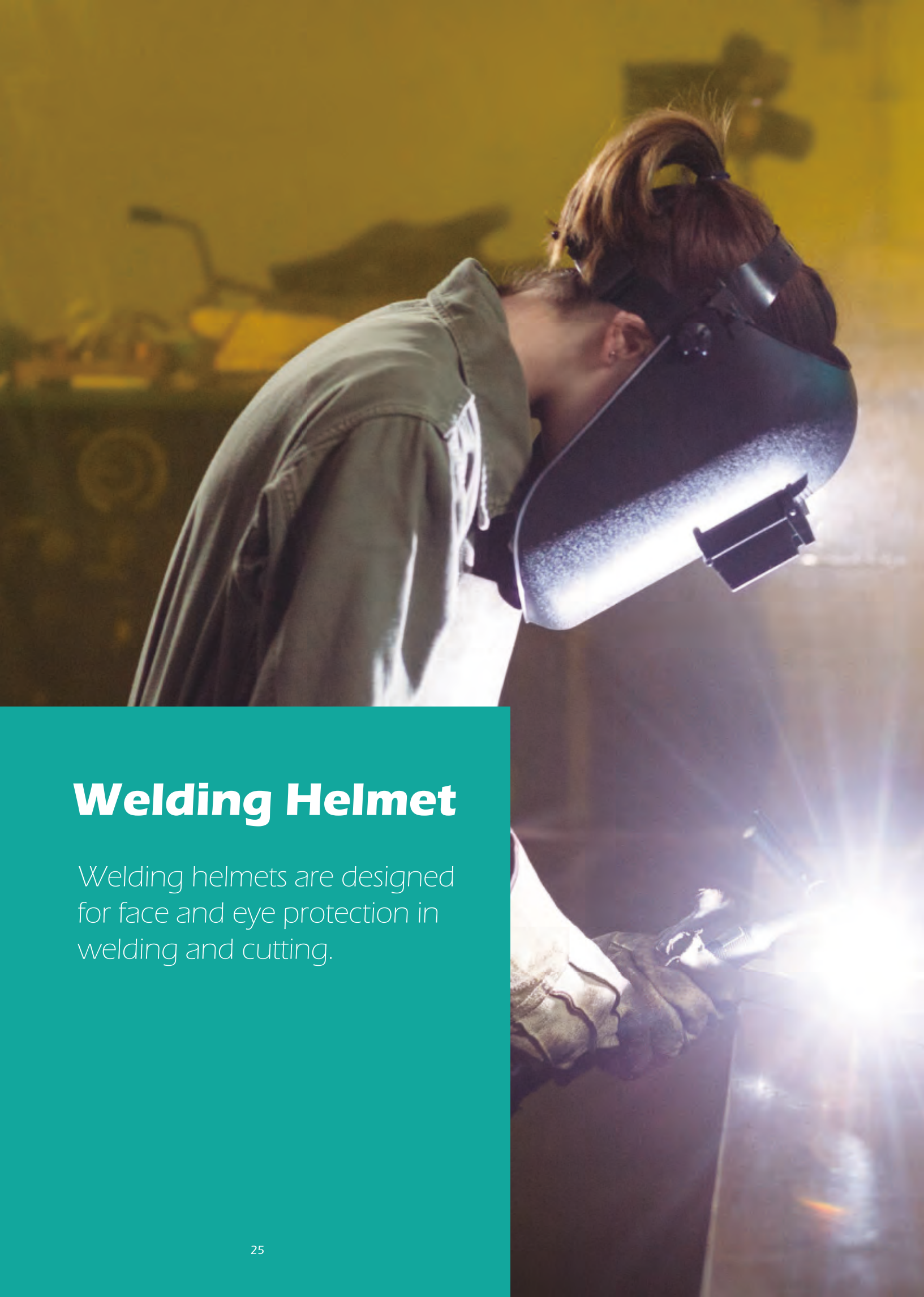

## **Welding Helmet**

Welding helmets are designed for face and eye protection in welding and cutting.

Since 1978

# Welding Helmets



**Welding Helmet**

- Lift-front lens holder
- Lens Size : 4¼ x 2" (108 x 51 mm)
- Material : PP
- Lens not included

**633P**

UK CA  
ANSI Z94.3



**Welding Helmet**

- Lift-front lens holder
- Lens Size : 4¼ x 2" (108 x 51 mm)
- Material : Nylon
- Lens not included

**633N**



**Welding Helmet**

- Fixed lens holder
- Lens Size : 4¼ x 2" (108 x 51 mm)
- Material : PP
- Lens not included

**DA11**

ANSI Z94.3



**Welding Helmet**

- Lift-front lens holder
- Lens Size : 4¼ x 2" (108 x 51 mm)
- Material : PP
- Lens not included

**DA11L**

ANSI Z94.3



**Welding Helmet**

- Lift-front lens holder
- ABS bracket
- Lens Size : 4¼ x 2" (108 x 51 mm)
- Material : PP
- Lens not included

**6PA2**

CE ANSI



**Welding Helmet**

- Lift-front lens holder
- Semi-Aluminum bracket
- Lens Size : 4¼ x 2" (108 x 51 mm)
- Material : PP
- Lens not included

**6PA3**

ANSI



**Welding Helmet**

- Fixed lens holder
- Lens Size : 4¼ x 2" (108 x 51 mm)
- Material : PP
- Lens not included

**635P**

ANSI



**Welding Handshield**

- Lens Size : 4¼ x 2" (108 x 51 mm)
- Material : PP
- Lens not included

**632P**

ANSI



**Welding Handshield**

- Lens Size : 4¼ x 2" (108 x 51 mm)
- Material : PP
- Lens not included

**567P**

ANSI

# Welding Helmets

BLUE EAGLE SAFETY



ANSI

### Welding Handshield

- Lens Size : 4¼ x 3¼"
- Material : PP
- Lens not included

**637P**



CE ANSI UK CA

### Welding Helmet

- Fixed lens holder
- Lens Size : 4¼ x 3¼"
- Material : PP
- Lens not included

**638P**



CE ANSI

### Welding Helmet

- Lift-front lens holder
- Lens Size : 110 x 90 mm
- Material : PP
- Lens not included

**733P**



CE ANSI

### Welding Helmet

- Fixed lens holder
- Lens Size : 5¼ x 4½"
- Material : PP
- Lens not included

**933P**



ANSI Z94.3

### Welding Helmet

- Fixed lens holder
- Lens Size : 5¼ x 4½"
- Material : PP
- Lens not included

**934P**



ANSI Z94.3

### Welding Helmet

- Lift-front lens holder
- Lens Size : 5¼ x 4½"
- Material : PP
- Lens not included

**936P**

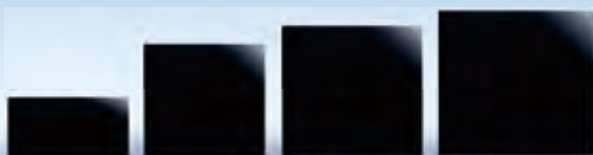

**633-11 638-11 733-11 934-11**

ANSI

### Welding Lens

- Size : 4¼ x 2" (108 x 51 mm), 4¼ x 3¼", 110 x 90 mm, 5¼ x 4½"
- Shade No. : 11
- Material : Glass



**633-04 638-04 733-04 934-04**

ANSI

### Cover Lens

- Size : 4¼ x 2" (108 x 51 mm), 4¼ x 3¼", 110 x 90 mm, 5¼ x 4½"
- Material : Polycarbonate

Since 1978

# Auto-darkening Welding Helmets



CE (ANSI) Z94.3

### Welding Helmet

- ADF Size : 133 x 114 x 10 mm
- LCD Viewing Area : 94 x 43 mm
- Optical Sensors : 4
- Light State : Shade 4
- Dark States : Group 1 : Shade 5, 7  
Group 2 : Shade 8, 9, 10, 11, 12
- Sensitivity Modes : 5 levels
- Operating Temperature : - 5 °C ~ 55 °C

**AW7R**



CE (ANSI) Z94.3

### Welding Helmet

- ADF Size : 133 x 114 x 10 mm
- LCD Viewing Area : 94 x 93 mm
- Optical Sensors : 2
- Light State : Shade 3
- Dark States : Group 1 : Shade 5, 7  
Group 2 : Shade 8, 9, 10, 11, 12
- Sensitivity Modes : 5 levels
- Operating Temperature : - 5 °C ~ 55 °C

**AW8R**

## FEATURES

### 01 SPECIAL MODE FOR TACK WELDING 2-STEP DELAY FUNCTION

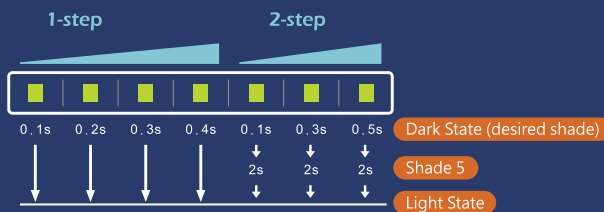

New digital design, there are seven different shade settings, 5 sensitivity settings and 7 different delay settings for selection, including the 2-step delay function specifically designed for tack welding, which can reduce eye fatigue caused by eyes having to continuously adapt to great light luminance difference during tack welding operation.

2-step delay function: When arc light disappears, in order to protect eyes, the filter shall first switch to shade 5 rather than directly switch to normal light state. The filter switches to normal light state only if arc light is not detected within 2s.

### 02 BUILT-IN RECHARGEABLE LITHIUM BATTERY

1. Battery replacement isn't needed so as to save the cost of every battery replacement.
2. The user can charge the battery regularly to maintain abundant power and don't have to wait until the power is exhausted to purchase and replace the battery, so important work will not be interrupted due to battery replacement.

### 03 USB FAST CHARGING

The same Micro-USB cable as most mobile phones and electronics is adopted to allow for charging everywhere.

### 04 CAN BE USED WITH OTHER WELDING HELMETS.

Open design, ADF dimension is standard 5.25"x4.5" (133x114mm), so it can be assembled on most 5.25"x4.5" (133x114mm) welding helmets.

### 05 PUSH-AND-TURN HEADGEAR

The headgear can be easily adjusted even with leather welding gloves.

### 06 INTELLIGENT ARC SENSORS

The intelligent arc sensors have the ability to distinguish between welding arc light and other light. In addition, the sensitivity of sensors is adjustable.

### 07 CERTIFIED BY CE, ANSI, CSA

Both items have passed the certification of CE EN 397, ANSI Z87.1, and CSA Z94.3.









**EM92BK**



**EM92RD**



**EM92BL**



**Earmuffs**

- NRR = 24 dB (ANSI S3.19)
- Cup Material : ABS
- Very comfortable to wear, foam ear cushion, foam head cushion, suitable for continuous use over long periods. It can be worn in 3 positions-overhead, behind neck or under chin.

EM92





**Earmuffs**

- NRR = 17 dB (ANSI S3.19)
- Cup Material : PE

EM62





**Earmuffs**

- NRR = 23 dB (ANSI S3.19)
- Cup Material : ABS

EM68



**Earmuffs**

- Cup Material : PE

EM66





**Earmuffs**

- NRR = 15 dB (ANSI S3.19)
- Cup Material : PE

EM65

Since 1978

# Earplugs



ANSI

### Earplugs

- NRR = 25 dB (ANSI S3.19)
- SNR = 29 dB (EN 352)
- Material : TPR
- With case, key chain, neck string

**NP363**



ANSI

### Earplugs

- NRR = 25 dB (ANSI S3.19)
- SNR = 29 dB (EN 352)
- Material : TPR
- With case, neck string

**NP364**



With neck string

**NP35K**



ANSI

### Earplugs

- NRR = 23 dB (ANSI S3.19)
- SNR = 26 dB (EN 352)
- Material : PVC
- With case, key chain, neck string

**NP353**



ANSI

### Earplugs

- NRR = 23 dB (ANSI S3.19)
- SNR = 26 dB (EN 352)
- Material : PVC
- With case, neck string

**NP354**



**NP35M**



With neck string

**NP32K**



CE ANSI

### Earplugs

- NRR = 32 dB (ANSI S3.19)
- SNR = 39 dB (EN 352)
- Material : Foam

**EP7**



CE ANSI

### Earplugs

- NRR = 32 dB (ANSI S3.19)
- SNR = 38 dB (EN 352)
- Material : Foam
- With neck string

**EP7C**



**NP32M**



# Face Mask

Face mask is designed to provide quality, reliable and comfortable respiratory protection against dust and odor.

## 4-ply Activated Carbon Face Mask (1 PC/ Bag)

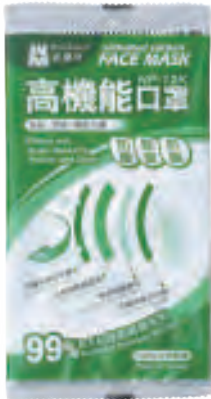

FDA Registered

- Low breathing resistance
- Outer layer : water resistance
- Activated carbon layer : odor absorbing
- Meltblown layer : particles filtering
- Inner layer : sweat absorbing
- Twin wire adjustable nosepiece ensures custom shape
- 99 % Bacterial Filtration Efficiency
- U.S.A. FDA Registration Number 3002822896

### Package

1 PC / Bag  
50 PCS / 

**NP12K**

## 4-ply Activated Carbon Face Mask (5 PCS/ Bag)



FDA Registered

- Low breathing resistance
- Outer layer : water resistance
- Activated carbon layer : odor absorbing
- Meltblown layer : particles filtering
- Inner layer : sweat absorbing
- Twin wire adjustable nosepiece ensures custom shape
- 99 % Bacterial Filtration Efficiency
- U.S.A. FDA Registration Number 3002822896

### Package

5 PCS / Bag  
50 PCS / 

**NP12**

## 3-ply Dust Face Mask (5 PCS/ Bag)



FDA Registered

### 3-ply Dust Face Mask

- Low breathing resistance
- Outer layer : water resistance
- Meltblown layer : particles filtering
- Inner layer : sweat absorbing
- Twin wire adjustable nosepiece ensures custom shape
- U.S.A. FDA Registration Number 3002822896

### Package

5 PCS / Bag  
50 PCS / 

**NP13**

## KIDS 4-ply Dust Face Mask



### FDA Registered

- Low breathing resistance
- Outer layer : water resistance
- DOUBLE Meltblown layer : better particles filtering
- Inner layer : sweat absorbing
- Twin wire adjustable nosepiece ensures custom shape
- 99 % Bacterial Filtration Efficiency
- U.S.A. FDA Registration Number 3002822896

### Package

50 PCS / 

### 3 Sizes can be selected

- NP3DS (for age 6-10)
- NP3DSS (for age 4-6)
- NP3DSSS (for age 2-4)

4-ply Dust Face Mask



- Low breathing resistance
- Outer layer : water resistance
- DOUBLE Meltblown layer : better particles filtering
- Inner layer : sweat absorbing
- Twin wire adjustable nosepiece ensures custom shape
- 99 % Bacterial Filtration Efficiency

Package

50 PCS / BOX

NP3D

5-ply Activated Carbon Face Mask



- Low breathing resistance
- Outer layer : water resistance
- Activated carbon layer : odor absorbing
- DOUBLE Meltblown layer : better particles filtering
- Inner layer : sweat absorbing
- Twin wire adjustable nosepiece ensures custom shape
- 99 % Bacterial Filtration Efficiency

Package

50 PCS / BOX

NP3DC

4-ply PM2.5 Dust Face Mask



- Low breathing resistance
- Outer layer : water resistance
- DOUBLE Meltblown layer : better particles filtering
- Inner layer : sweat absorbing
- Twin wire adjustable nosepiece ensures custom shape
- Complied with CNS 15980 PM2.5 standard

**Package**

25 PCS / 

**NP4D**

Since 1978

Dust Masks

### 5-ply PM2.5 Activated Carbon Face Mask

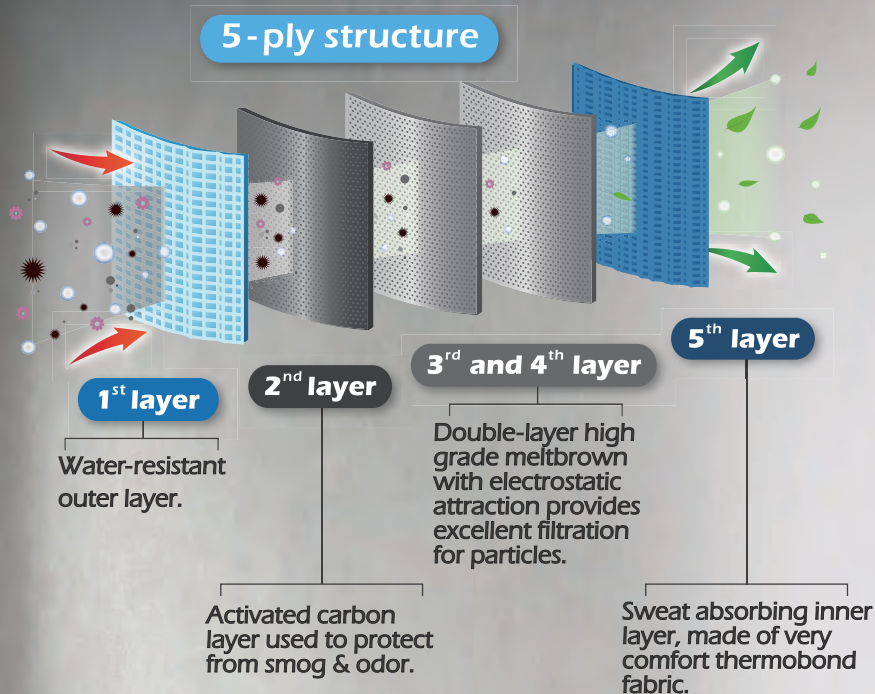

FDA Registered



- Low breathing resistance
- Outer layer : water resistance
- Activated carbon layer : odor absorbing
- DOUBLE Meltblown layer : better particles filtering
- Inner layer : sweat absorbing
- Twin wire adjustable nosepiece ensures custom shape
- Complied with CNS 15980 PM2.5 standard
- U.S.A. FDA Registration Number 3002822896

Package

25 PCS / BOX

NP4DC





## ▶ RESPIRATORY PROTECTION ◀



### Respirator

- Single-cartridge
- Two exhalation valves
- Material : TPE
- Fit RC201 ~ RC209
- Cartridges not included

**NP305**



### Respirator

- Dual-cartridge
- Two exhalation valves
- Material : TPE
- Fit RC201 ~ RC209
- Cartridges not included

**NP306**



### Cartridges

- RC201 : For dust
- RC202 : For organic vapours (with boiling point > 65 °C), mists of low toxicity
- RC203 : For Spray painting and organic vapours (with boiling point > 65 °C) of low toxicity
- RC205 : For sulphur dioxide and acid gases of low toxicity
- RC206 : For organic vapours (with boiling point > 65 °C), acid gases, and inorganic gases (such as chlorine Cl<sub>2</sub> and hydrogen sulphide H<sub>2</sub>S) of low toxicity
- RC209 : For agricultural sprays

Limitations of use : All cartridges cannot be used where the oxygen concentration is lower than 17 % in volume nor be used for organic vapours with boiling point lower than 65 °C.



**Respirator**

- Single-cartridge
- Two exhalation valves
- Material : TPE
- Fit cartridge RC101
- Cartridges included

**NP303**



**Respirator**

- Dual-cartridge
- Two exhalation valves
- Material : TPE
- Fit cartridge RC101
- Cartridges included

**NP304**



**Dust Cartridge**

- For dust filtering

**RC101**



**Respirator**

- Single-cartridge (NP307)
- Dual-cartridge (NP308)
- Two exhalation valves
- Material : TPE
- Fit RC1~RC9
- Cartridges not included

**NP307**  
**NP308**



**Cartridges**

- RC1 : For dust
- RC2 : For organic vapours (with boiling point > 65 °C), mists of low toxicity
- RC3 : For Spray painting and organic vapours (with boiling point > 65 °C) of low toxicity
- RC5 : For sulphur dioxide and acid gases of low toxicity
- RC6 : For organic vapours (with boiling point > 65 °C), acid gases, and inorganic gases (such as chlorine Cl<sub>2</sub> and hydrogen sulphide H<sub>2</sub>S) of low toxicity
- RC9 : For agricultural sprays



**Dust Mask**

- The air space provides user better breathing experience.
- Filter is replaceable.

**NP22**



**Activated Carbon Dust Mask**

- The air space provides user better breathing experience.
- Filter is replaceable.

**NP22A**



**Dust Filter**

- For dust mask NP22

**PF2**

**Activated Carbon Dust Filter**

- For dust mask NP22A

**PF3A**



## **Safety Helmet**

The safety helmet is made to protect the user's head from injury due to falling objects, impact and rain.

Since 1978

# Safety Helmets



**SU3R**

**M3**

**M2**

**M1**

Material	
<b>ABS</b>	<b>HR36</b>
<ul style="list-style-type: none"> <li>Ratchet headgear, 6-point nylon suspension SU3R</li> <li>Chin strap M1 included</li> <li>Class E - 20,000 V (ANSI Z89.1)</li> <li>No exposed metal part</li> <li>EN 397, ANSI Z89.1</li> </ul>	

Material	
<b>ABS</b>	<b>HC36</b>
<ul style="list-style-type: none"> <li>Pin-lock headgear, 6-point nylon suspension M3</li> <li>Chin strap M1 included</li> <li>No exposed metal part</li> <li>EN 397</li> </ul>	

Material	
<b>ABS</b>	<b>HC32</b>
<ul style="list-style-type: none"> <li>Pin-lock headgear, 6-point PE suspension M2</li> <li>Chin strap M1 included</li> <li>No exposed metal part</li> <li>EN397</li> </ul>	

Material	
<b>HDPE</b>	<b>HR35</b>
<ul style="list-style-type: none"> <li>Ratchet headgear, 6-point nylon suspension SU3R</li> <li>Chin strap M1 included</li> <li>No exposed metal part</li> <li>EN 397</li> </ul>	

Material	
<b>HDPE</b>	<b>HC35</b>
<ul style="list-style-type: none"> <li>Pin-lock headgear, 6-point nylon suspension M3</li> <li>Chin strap M1 included</li> <li>No exposed metal part</li> <li>EN 397</li> </ul>	

Material	
<b>HDPE</b>	<b>HC31</b>
<ul style="list-style-type: none"> <li>Pin-lock headgear, 6-point PE suspension M2</li> <li>Chin strap M1 included</li> <li>No exposed metal part</li> <li>EN397</li> </ul>	

# Safety Helmets

BLUE EAGLE SAFETY



**ANSI**

**SU8R**

**Safety Helmet**

- Ratchet headgear, 8-point nylon suspension SU8R
- Chin strap M1 included
- ANSI Z89.1 class E

**HR82**

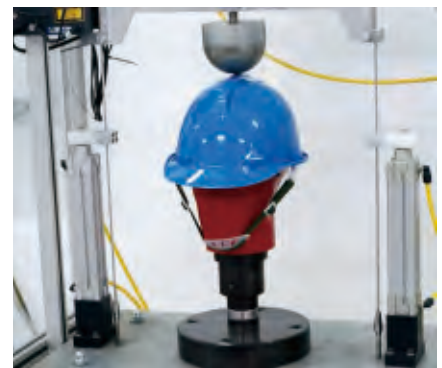

Since 1978

# Bump Caps



CE

**Bump Cap**

- Material : HDPE
- 4-point PE suspension M6
- Color : white
- EN 812
- Chin strap not included

**BP65WH**



CE

**Bump Cap**

- Material : HDPE
- 4-point PE suspension M6
- Color : yellow
- EN 812
- Chin strap not included

**BP65YE**



CE

**Bump Cap**

- Material : HDPE
- 4-point PE suspension M6
- Color : blue
- EN 812
- Chin strap not included

**BP65BL**



CE

**Bump Cap**

- Material : HDPE
- 4-point PE suspension M6
- Color : orange
- EN 812
- Chin strap not included

**BP65OR**



CE

**Bump Cap**

- Material : HDPE
- 4-point PE suspension M6
- Color : red
- EN 812
- Chin strap not included

**BP65RD**



CE

**Bump Cap**

- Material : HDPE
- 4-point PE suspension M6
- Color : green
- EN 812
- Chin strap not included

**BP65GN**



CE

**Cap Suspension**

- 4 - point PE suspension
- EN 812

**M6**



BLUE EAGLE®

► BUMP CAPS ◀





# Hoods

*Various of hoods used in sandblasting, spray painting, arc-welding, etc.*



**Air-supplied Sandblasting Hood**

- For all sandblasting operations
- Air regulator provides smooth and low noise air flow

**NP503**



**Air-supplied Spray Painting Hood**

- Light in weight
- Replaceable visor
- Air regulator provides smooth and low noise air flow

**NP505**



**Arc-welding Leather Hood**

- Lift-fornt lens holder
- Used in narrow working areas for arc-welding operations

**NP901**



**Chemical Hood**

- Dual-cartridge type
- Fit cartridges RC203
- Light in weight

**NP312**



**Air-supplied Mask**

- Including half-mask, belt, air regulator, and quick connector.
- Air regulator provides smooth and low noise air flow.

**NP375**







## **Emergency Eye / Body Wash**

Emergency eyewash and shower are used to flush the user's eyes, head, and body for emergency situations.

Since 1978

# Emergency Eye / Body Wash



## Emergency Eyewash (wall mounted type)

- Stainless steel basin  
Diameter : 30 cm
- Sprayheads with protective covers

**EW402**



## Emergency Eyewash Bottle

- Size : 21 cm(H) x 7 cm (W)
- Fill with sterile water before use

**EW6**

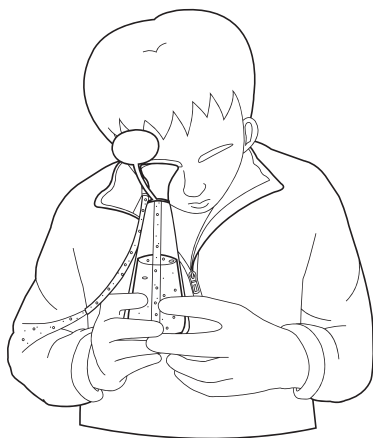

**EW407**

## Emergency Eyewash (pedestal mounted type)

- Basin  
Material : Stainless steel  
Diameter : 30 cm
- Sprayheads with protective covers
- Flange  
Material : Stainless steel  
Diameter : 25 cm



**EW607**

## Emergency Eyewash and Shower

- Basin  
Material : Stainless steel  
Diameter : 30 cm
- Sprayheads with protective covers
- Flange  
Material : Stainless steel  
Diameter : 25 cm
- Copper alloy shower head



## **Fire / Welding Blankets**

Fire blanket offers help putting out dangerous fires. Welding blanket provides excellent protection from sparks, spatter and slag generated by welding.



## ATG1515

### Fire Blanket

Description : It offers help putting out dangerous fires within the home, workplace, car or boat.

Size : 150 x 150 cm

Weight : 430 g/m<sup>2</sup>

Material : Woven fiberglass fabric

Temperature Tolerance : 530 °C



## HTX-600

### Welding Blanket

Description : The welding blankets provide excellent protection from sparks, spatter and slag generated by welding or metal-cutting application. The blankets also provide resistance to most chemicals.

Size : 150 x 89 cm

Weight : 600 g/m<sup>2</sup>

Material : Amorphous silica fabric

Temperature Tolerance : 1600 °C



## HTX-1000

### Enhanced Welding Blanket

Description : The welding blankets provide excellent protection from sparks, spatter and slag generated by welding or metal-cutting application. The blankets also provide resistance to most chemicals.

Size : 150 x 89 cm

Weight : 1100 g/m<sup>2</sup>

Material : Amorphous silica fabric

Temperature Tolerance : 1600 °C



# **Aluminized Clothing**

Aluminized Clothing provides excellent protection against radiant heat and molten metal splashes.

# HEAT AND FLAME PROTECTION

BLUE EAGLE aluminized clothing (heat protective clothing) offers excellent protection against radiant heat and molten metal splashes, and is suitable for use in steel mills, metal foundries, glass works, and other places with high levels of radiant heat.

When tested according to **EN 11612, Protective clothing - clothing to protect against heat and flame**, BLUE EAGLE aluminized clothing shows excellent performances.

## Limited Flame Spread **A1**

It shows perfect performances : no flame, no molten debris, no hole, no afterglow, no afterflame.

## Convective Heat **B1**

★☆☆

## Radiant Heat **C3**

★★★★☆

## Molten Aluminium Splashes **D2**

★★★☆☆

## Molten Iron Splashes **E3**

★★★★ Highest Level

## Contact Heat **F2**

★★★☆☆



**Gloves**  
**AL145**

### BACK OF THE HAND

Aluminized outside provides protections against radiant heat and molten metal splashes.

### FINGER

In the test of burning behavior, it shows the highest performance level 4.

### PALM AREA

Woven Aramid fabric, which provides protections against contact heat and has mechanical properties.  
Abrasion resistance: level 2  
Blade cut resistance: level 3  
Tear resistance : level 4

Model	Length	Type
AL145	35 cm (14 inches)	Gloves
AL165	40 cm (16 inches)	Gloves

## Aluminized Gloves

The aluminized protective gloves provide excellent protections against radiant heat and molten metal splashes. Ideal for use in steel mills, casting shops, heat treating operations and foundries.

## Standards

**EN 407** - Protective gloves against thermal risks (heat and / or fire)

**EN 388** - Protective gloves against mechanical risks

Since 1978

# HEAT REFLECTION PROTECTION

## Thermal Risks Test results of EN 407

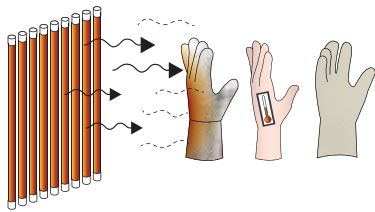

Radiant Heat (highest level)	
Position the glove in front of a 20 kW/m <sup>2</sup> radiant heat source. Measure and record how long it takes to increase the inner side temperature of the glove with 24°C.	
Performance Level	Heat Transfer Level, t <sub>24</sub> (second)
1	≥ 7
2	≥ 20
3	≥ 50
4	≥ 95

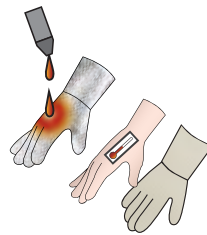

Small Splashes Molten Metal	
The test is based on the number of drops of molten metal that generates a temperature increase between the glove material and the skin with 40°C.	
Performance Level	Number of droplets
1	≥ 10
2	≥ 15
3	≥ 25
4	≥ 35

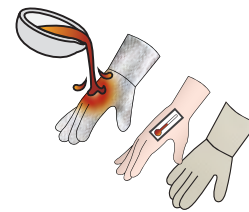

Large Quantities of Molten Metal	
The PVC foil skin-simulant shall not exhibit any smoothness or other changes to the grained surface with the relevant quantities of molten iron used below.	
Performance Level	Quantities of Molten Iron
1	30 g
2	60 g
3	120 g
4	200 g



Contact Heat		
Place the glove on a calorimeter, and bring the heated metal into contact with the calorimeter with a standard force. Measure how long does it take for the inner side of the glove to become 10°C warmer than it was.		
Performance Level	Temperature (°C)	Threshold Time (s)
1	100	≥ 15
2	250	≥ 15
3	350	≥ 15
4	500	≥ 15



Burning Behaviour (highest level)		
Place a burner with standard flame below the glove. After 15 seconds, remove the burner. Measure and record the After flame time and After glow time.		
Performance Level	After flame time (second)	After glow time (second)
1	≤ 20	N/A
2	≤ 10	≤ 120
3	≤ 3	≤ 25
4	≤ 2	≤ 5



Convective Heat	
Position the glove above a burner. Ignite the burner, measure and record how long it takes to increase the inner side temperature of the glove with 24°C.	
Performance Level	Heat Transfer Index, HTI (second)
1	≥ 4
2	≥ 7
3	≥ 10
4	≥ 18

## Mechanical Risks Test results of EN 388

Mechanical Risks					
Test	Level 1	Level 2	Level 3	Level 4	Level 5
Abrasion Resistance (number of cycles)	100	500	2000	8000	-
Blade Cut Resistance (cut index)	1.2	2.5	5.0	10.0	20.0
Tear Resistance (N)	10	25	50	75	-
Puncture Resistance (N)	20	60	100	150	-





## Heat Reflective Aluminized Hood

Model :

AL19

Features :

- Aluminized visor
- Aluminized FR fabric
- Reflect radiant heat away
- Face feels cooler
- More comfortable
- Block UV
- Lift-front design



### Aluminized Hood

- Aluminized visor
- Aluminized FR fabric
- Reflect radiant heat
- Block UV
- Equipped safety cap

**AL1**



### Aluminized Faceshield

- Aluminized visor
- Aluminized FR fabric
- Reflect radiant heat
- Block UV

**ALBR3**



### Aluminized Visor / Bracket

- Aluminized visor
- Aluminum bracket
- Reflect radiant heat
- Block UV

**A4  
(Bracket)**

**FCR3  
(Visor)**

## Aluminized Visor

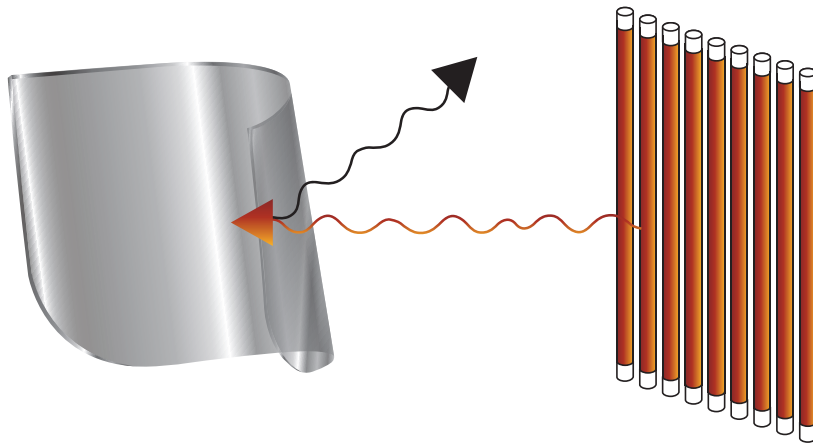

- Aluminized visor reflects most radiant heat, so user's face will feel more comfortable and cooler.
- IR-reflectance > 75 %
- RHTI24 > 95 seconds. Achieve the highest level of radiant heat performance level when tested according to EN 6942-Protection against heat and fire-Method of test : Evaluation of materials and material assemblies when exposed to a source of radiant heat.
- Block both UV and IR.

## Radiant Heat

Radiant heat is a heat which radiates out from high temperature objects, such as melt iron and melt glass. The total amount of radiation increases steeply as the temperature rises; it grows as  $T^4$ , where  $T$  is the absolute temperature of the body. The total radiative intensity of a black body rises as the fourth power of the absolute temperature, as expressed by the — Stefan Boltzmann law. In the plot, the area under each curve grows rapidly as the temperature increases. For example, molten iron at the temperature of 1800 K (1527 °C) radiates 1296 times as much energy as an object at room temperature 300 K (27 °C). In small doses, radiant heat can be warm and welcoming. However, the large amount of radiant heat generated by high mass, high temperature object, such as molten metal in steel mills, can be very dangerous and a serious threat of workers' safety.

Radiant heat travels in invisible waves through space. When radiant heat hit a person, it is absorbed, converted into heat, and would cause unbearable pain and followed by second-degree burns. That is why workers need to wear aluminized apparels and visors.

When radiant heat hit a clear or tinted faceshield, its temperature would be increased and would cause it to melt. Unlike clear or tinted faceshields, BLUE EAGLE aluminized apparels and faceshields can reflect radiant heat and limit a rise in temperature on the apparels and visors to protect users.

## Clear Visor

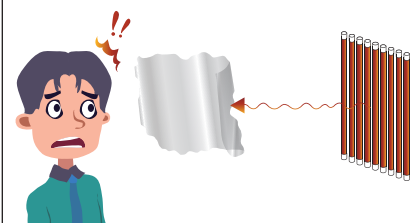

### Disadvantages

- A Clear visor only absorbs a little radiant heat, and most of the heat still transmits to user's face and eyes.
- User's face feels hot, and radiant heat harms user's face and eyes.
- Since the visor is clear, users are forced to look at the very bright objects, such as molten metal, directly.

## Tinted Visor

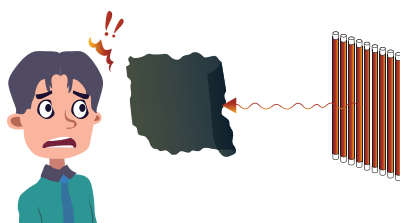

### Disadvantages

- A Tinted visor only absorbs some radiant heat, and most of the heat still transmits to user's face and eyes.
- User's face feels hot, and radiant heat harms user's face and eyes.

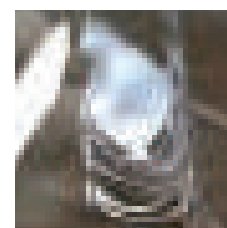

A clear visor molten by radiant heat

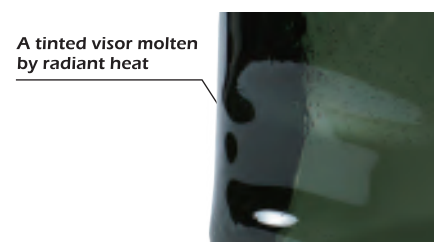

A tinted visor molten by radiant heat



Coat	Trousers
Model : AL2	Model : AL3

Chest circle : 48 "	Waist circle : 34 "
Coat length : 29 "	Trouser length : 39 "

- Features**
- Excellent radiant heat protection
  - Excellent molten metal splashes protection
  - Flame Resistance (FR)
  - Contact heat protection
  - Convective heat protection
  - Coat and trouser styles

Robe
Model : AL29

Chest circle : 57 "	Length : 51 "
------------------------	------------------

- Features**
- Excellent radiant heat protection
  - Excellent molten metal splashes protection
  - Flame Resistance (FR)
  - Contact heat protection
  - Convective heat protection
  - Robe style
  - Easily put on and take off

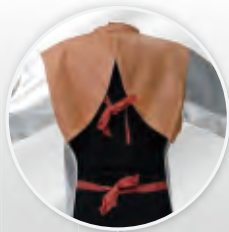

**Apron with sleeves**

Model :

AL6

Chest width :      Length :  
27 "                      49 "

**Features**

- Excellent radiant heat protection
- Excellent molten metal splashes protection
- Flame Resistance (FR)
- Contact heat protection
- Convective heat protection
- Apron with sleeves style
- Light weight
- Front protection only
- Easily put on and take off

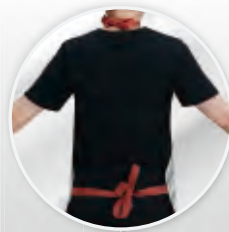

**Apron**

Model :

AL7

Width :                      Length :  
27 "                      39 "

**Features**

- Excellent radiant heat protection
- Excellent molten metal splashes protection
- Flame Resistance (FR)
- Contact heat protection
- Convective heat protection
- Apron with sleeves style
- Light weight
- Front protection only
- Easily put on and take off





### Boots

- Aluminized FR fabric
- Radiant heat protection
- Molten metal splashes protection
- Reflect radiant heat
- Steel toe, boots height : 8"

**AL4**



### Gaiters

- Aluminized FR fabric
- Radiant heat protection
- Molten metal splashes protection
- Reflect radiant heat
- Height : 9"

**AL5**



### Sleeves

- Aluminized FR fabric
- Radiant heat protection
- Molten metal splashes protection
- Reflect radiant heat
- Length : 22"

**AL8**

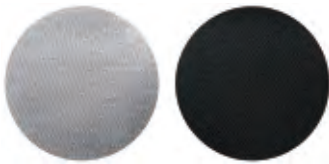

### Aluminized Fire Resistant Rayon Fabric

Providing excellent protection against radiant heat and molten metal splashes. Rayon fabric offer outstanding soft texture and sweat absorption. No fiberglass is added to prevent users from shin redness & itchiness.



### Aluminized Aramid/Oxidized Pan Fiber Fabric

Providing the best molten metal splashes protection. In addition, it is soft and lightweight. Comfortable to wear.



★ EN 11612 : Protective clothing-Clothing to protect against heat and flame



### Limited Flame Spread

Following the test method (A1). No specimen shall suffer flaming to the top or either side edge; No specimen shall suffer hole formation; No specimen shall melt or suffer flaming or molten debris; the mean value of after flame time shall be under 2 s; the mean value of afterglow time shall be under 2 s.

Performance Level	A1	Afterflame time	0 second
		Afterglow time	0 second
Afterflame time			0 second
Afterglow time			0 second

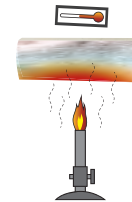

### Convective Heat

Position the clothing above a standard burner. Ignite the burner, measure and record how long it takes to increase the other side temperature of the clothing with 24°C.

Performance Level	Heat transfer index HTI 24 ( s )	
	min.	max.
B1	4	< 10.0
B2	10.0	< 20.0
B3	20.0	

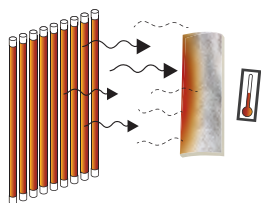

### Radiant Heat

Position the clothing in front of a 20 kW/m<sup>2</sup> radiant heat source, measure and record how long it takes to increase the other side temperature of the clothing with 24°C.

Performance Level	Heat transfer index RHTI 24 (second)	
	min.	max.
C1	7.0	< 20.0
C2	20.0	< 50.0
C3	50.0	< 95.0
C4	95.0	

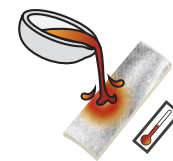

### Molten Aluminum Splashes

Pouring certain grams of molten aluminum onto the clothing and exam the sign of damage on the other side.

Performance Level	Grams	
	min.	max.
D1	100	< 200
D2	200	< 350
D3	350	

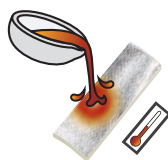

### Molten Iron Splashes

Pouring certain grams of molten iron onto the clothing and exam the sign of damage on the other side.

Performance Level	Grams	
	min.	max.
E1	60	< 120
E2	120	< 200
E3	200	



### Contact Heat

Place clothing on a calorimeter, and bring a 250°C heated metal into contact with the calorimeter with a standard force. Measure how long does it take for the other side of the clothing to become 10°C warmer than it was.

Performance Level	Threshold Time ( s )	
	min.	max.
F1	5.0	< 10.0
F2	10.0	< 15.0
F3	15.0	



### Full Body Safety Harness

- Belt : 45 mm (W), polyester
- Rope : Ø14 mm x 1.5 M, polyester
- DOUBLE-LOCK safety hook
- Hook opening : 17 mm
- One D-ring

**KA91**



### Full Body Safety Harness

- Belt : 45 mm (W), polyester
- Rope : Ø14 mm x 1.5 M, polyester
- DOUBLE-LOCK safety hook
- Hook opening : 55 mm
- One D-ring

**KA91H**



### Full Body Safety Harness

- Belt : 50 mm (W), nylon
- Rope : Ø14 mm x 1.5 M, polyester
- DOUBLE-LOCK safety hook
- Hook opening : 17 mm
- Two D-rings

**NP787**



### Lineman's Safety Belt

- Belt : 60 mm (W), nylon
- Rope : Ø14 mm x 1.5 M, polyester
- DOUBLE-LOCK safety hook
- Hook opening : 17 mm
- Two D-rings

**NP739**



**Safety Belt**

- Belt : 60 mm (W) x 1.2 M (L), nylon; Rope : Ø14 mm x 1.5 M, polyester
- DOUBLE-LOCK safety hook, opening : 17 mm
- Two D-rings

**NP737**



**Safety Belt**

- Belt : 50 mm (W) x 1.2 M (L), nylon; Rope : Ø14 mm x 1.5 M, polyester
- DOUBLE-LOCK safety hook, opening : 17 mm
- One D-ring

**NP727**

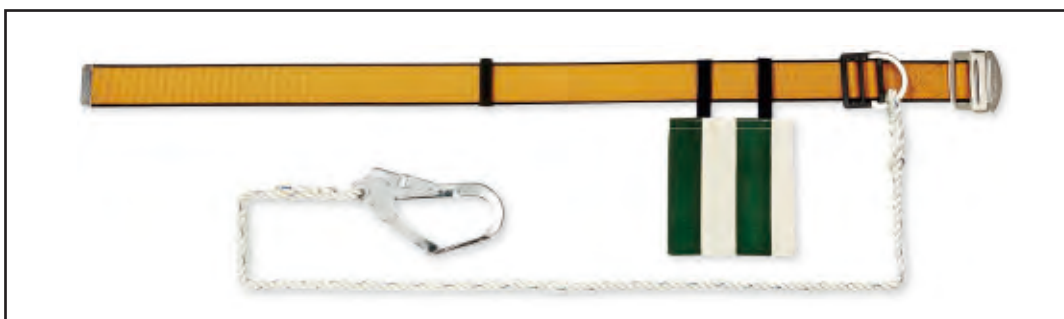

**Safety Belt**

- Belt : 60 mm (W) x 1.2 M (L), nylon; Rope : Ø14 mm x 1.5 M, polyester
- DOUBLE-LOCK safety hook, opening : 55 mm
- One D-ring

**NP758**



**Lineman's Safety Belt**

- Belt : 50 mm (W) x 1.2 M (L), nylon; Pad belt width : 80 mm; Rope : Ø16 mm x 2.0 M, polyester
- DOUBLE-LOCK safety hook, opening : 17 mm.
- Two D-rings, one adjustable fall arrestor

**NP747**



